

沖縄市民会館 DMX No.表1

| 名称 | | DMX | CH |
|-------------------|-----|-----|----|
| 1 BL 上下 | #W | 1 | 1 |
| | #W | 2 | 2 |
| | #72 | 3 | 3 |
| | #78 | 4 | 4 |
| 1 BL 中 | #W | 1 | 5 |
| | #W | 2 | 6 |
| | #72 | 3 | 7 |
| | #78 | 4 | 8 |
| 2 BL 上下 | #W | 1 | 9 |
| | #W | 2 | 10 |
| | #72 | 3 | 11 |
| | #78 | 4 | 12 |
| 2 BL 中 | #W | 1 | 13 |
| | #W | 2 | 14 |
| | #72 | 3 | 15 |
| | #78 | 4 | 16 |
| 3 BL 上下 | #W | 1 | 17 |
| | #W | 2 | 18 |
| | #72 | 3 | 19 |
| | #78 | 4 | 20 |
| 3 BL 中3 | #W | 1 | 21 |
| | #W | 2 | 22 |
| | #72 | 3 | 23 |
| | #78 | 4 | 24 |
| PS No. 1~8 | | 1 | 25 |
| | | 2 | 26 |
| | | 3 | 27 |
| | | 4 | 28 |
| | | 5 | 29 |
| | | 6 | 30 |
| | | 7 | 31 |
| | | 8 | 32 |
| 1 SUS No. 1~24 | | 1 | 33 |
| | | 2 | 34 |
| | | 3 | 35 |
| | | 4 | 36 |
| | | 5 | 37 |
| | | 6 | 38 |
| | | 7 | 39 |
| | | 8 | 40 |
| | | 9 | 41 |
| | | 10 | 42 |

| 名称 | | DMX | CH | |
|-------------------|-------------------|-----|----|----|
| 1 SUS No. 1~24 | | 11 | 43 | |
| | | 12 | 44 | |
| | | 13 | 45 | |
| | | 14 | 46 | |
| | | 15 | 47 | |
| | | 16 | 48 | |
| | | 17 | 49 | |
| | | 18 | 50 | |
| | | 19 | 51 | |
| | | 20 | 52 | |
| | | 21 | 53 | |
| | | 22 | 54 | |
| | | 23 | 55 | |
| | | 24 | 56 | |
| | 2 SUS No. 1~24 | | 1 | 57 |
| | | | 2 | 58 |
| | | | 3 | 59 |
| | | | 4 | 60 |
| | | | 5 | 61 |
| | | | 6 | 62 |
| | | | 7 | 63 |
| | | | 8 | 64 |
| | | | 9 | 65 |
| | | | 10 | 66 |
| | | 11 | 67 | |
| | | 12 | 68 | |
| | | 13 | 69 | |
| | | 14 | 70 | |
| | | 15 | 71 | |
| | | 16 | 72 | |
| | | 17 | 73 | |
| | | 18 | 74 | |
| | | 19 | 75 | |
| | | 20 | 76 | |
| | | 21 | 77 | |
| | | 22 | 78 | |
| | | 23 | 79 | |
| | | 24 | 80 | |
| 3 SUS No. 1~24 | | 1 | 81 | |
| | | 2 | 82 | |
| | | 3 | 83 | |
| | | 4 | 84 | |

| 名称 | | DMX | CH | |
|-------------------|-------------------|-----|-----|-----|
| 3 SUS No. 1~24 | | 5 | 85 | |
| | | 6 | 86 | |
| | | 7 | 87 | |
| | | 8 | 88 | |
| | | 9 | 89 | |
| | | 10 | 90 | |
| | | 11 | 91 | |
| | | 12 | 92 | |
| | | 13 | 93 | |
| | | 14 | 94 | |
| | | 15 | 95 | |
| | | 16 | 96 | |
| | | 17 | 97 | |
| | | 18 | 98 | |
| | | 19 | 99 | |
| | | 20 | 100 | |
| | | 21 | 101 | |
| | | 22 | 102 | |
| | | 23 | 103 | |
| | | 24 | 104 | |
| | 4 SUS No. 1~24 | | 1 | 105 |
| | | | 2 | 106 |
| | | | 3 | 107 |
| | | | 4 | 108 |
| | | 5 | 109 | |
| | | 6 | 110 | |
| | | 7 | 111 | |
| | | 8 | 112 | |
| | | 9 | 113 | |
| | | 10 | 114 | |
| | | 11 | 115 | |
| | | 12 | 116 | |
| | | 13 | 117 | |
| | | 14 | 118 | |
| | | 15 | 119 | |
| | | 16 | 120 | |
| | | 17 | 121 | |
| | | 18 | 122 | |
| | | 19 | 123 | |
| | | 20 | 124 | |
| | | 21 | 125 | |
| | | 22 | 126 | |
| | | 23 | 127 | |
| | | 24 | 128 | |

| 名称 | | DMX | CH |
|-------------------------|-----|-----|----|
| UH 上 | #71 | 129 | |
| | #72 | 130 | |
| | #78 | 131 | |
| | #63 | 132 | |
| | #71 | 133 | |
| | #72 | 134 | |
| UH 中 | #78 | 135 | |
| | #63 | 136 | |
| | #71 | 137 | |
| | #72 | 138 | |
| | #78 | 139 | |
| | #63 | 140 | |
| UH 下 | #71 | 141 | |
| | #72 | 142 | |
| | #78 | 143 | |
| TL 上 | #63 | 144 | |
| | 1 | 145 | |
| | 2 | 146 | |
| TL 下 | 1 | 147 | |
| | 2 | 148 | |
| Foot/ オケ迫り (切り替え) | 1 | 149 | |
| | 2 | 150 | |
| | 3 | 151 | |
| | 4 | 152 | |
| FC前/ オケ迫り (切り替え) | 1 | 153 | |
| | 2 | 154 | |
| | 3 | 155 | |
| | 4 | 156 | |
| 上FC | 1 | 157 | |
| | 2 | 158 | |
| | 3 | 159 | |
| | 4 | 160 | |
| | 5 | 161 | |
| | 6 | 162 | |
| | 7 | 163 | |
| | 8 | 164 | |
| | 9 | 165 | |
| | 10 | 166 | |
| | 11 | 167 | |
| | 12 | 168 | |
| | 13 | 169 | |
| | 14 | 170 | |
| | 15 | 171 | |
| | 16 | 172 | |
| | 17 | 173 | |
| | 18 | 174 | |

| 名称 | | DMX | CH |
|--------------|-----|------|-----|
| FC 上 | | 13 | 169 |
| | | 14 | 170 |
| | | 15 | 171 |
| | | 16 | 172 |
| | | 17 | 173 |
| | | 18 | 174 |
| LH 上 (FC) | #72 | LH上1 | 175 |
| | #59 | LH上2 | 176 |
| | #22 | LH上3 | 177 |
| | #40 | LH上4 | 178 |
| FC 下 | | 1 | 179 |
| | | 2 | 180 |
| | | 3 | 181 |
| | | 4 | 182 |
| | | 5 | 183 |
| | | 6 | 184 |
| | | 7 | 185 |
| | | 8 | 186 |
| | | 9 | 187 |
| | | 10 | 188 |
| | | 11 | 189 |
| | | 12 | 190 |
| | | 13 | 191 |
| | | 14 | 192 |
| | | 15 | 193 |
| | | 16 | 194 |
| | | 17 | 195 |
| | | 18 | 196 |
| LH 下 (FC) | #72 | LH下1 | 197 |
| | #59 | LH下2 | 198 |
| | #22 | LH下3 | 199 |
| | #40 | LH下4 | 200 |
| FC 後 | | 1 | 201 |
| | | 2 | 202 |
| | | 3 | 203 |
| | | 4 | 204 |
| | | 5 | 205 |
| | | 6 | 206 |
| FC 盆 | | 1 | 207 |
| | | 2 | 208 |
| | | 3 | 209 |
| | | 4 | 210 |

| 名称 | | DMX | CH |
|-----|------|-----|-----|
| 上花道 | Foot | 上 1 | 211 |
| | | 上 2 | 212 |
| | FC | 1 | 213 |
| 下花道 | Foot | 下 1 | 214 |
| | | 下 2 | 215 |
| | FC | 1 | 216 |

沖縄市民会館 DMX No.表2

| 名称 | | DMX | CH |
|-----------|------|-----|-----|
| 1Fr 上手 | 下段 | 1 | 217 |
| | | 2 | 218 |
| | 上段 | 3 | 219 |
| | | 4 | 220 |
| 1Fr 下手 | 下段 | 1 | 221 |
| | | 2 | 222 |
| | 上段 | 3 | 223 |
| | | 4 | 224 |
| 2Fr 上手 | 下段 | 1 | 225 |
| | | 2 | 226 |
| | 中段 | 3 | 227 |
| | | 4 | 228 |
| | 上段 | 5 | 229 |
| | | 6 | 230 |
| 2Fr 下手 | 下段下段 | 1 | 231 |
| | | 2 | 232 |
| | 中段 | 3 | 233 |
| | | 4 | 234 |
| | 上段 | 5 | 235 |
| | | 6 | 236 |

| 名称 | | DMX | CH | |
|-------------------------|--------|-----|----------------|-----|
| CLB No. 1~12 (※使用不可) | | 1 | 258 | |
| | | 2 | 259 | |
| | | 3 | 260 | |
| | | 4 | 261 | |
| | | 5 | 262 | |
| | | 6 | 263 | |
| | | 7 | 264 | |
| | | 8 | 265 | |
| | | 9 | 266 | |
| | | 10 | 267 | |
| | | 11 | 268 | |
| | | 12 | 269 | |
| 1天反(前) | 外 | 1 | 270 | |
| | 内 | 2 | 271 | |
| | | 3 | 272 | |
| | 外 | 4 | 273 | |
| | 2天反(中) | 外 | 1 | 274 |
| | | 内 | 2 | 275 |
| | 外 | 3 | 276 | |
| | 2天反(後) | 外 | 4 | 277 |
| | | 内 | 5 | 278 |
| | 外 | 6 | 279 | |

| 名称 | | DMX | CH |
|-------------------------------|---|-----|-----|
| 客電 DMX No. 281~305 | | 1 | 281 |
| | | 2 | 282 |
| | | 3 | 283 |
| | | 4 | 284 |
| | | 5 | 285 |
| | | 6 | 286 |
| | | 7 | 287 |
| | | 8 | 288 |
| | | 9 | 289 |
| | | 10 | 290 |
| | | 11 | 291 |
| | | 12 | 292 |
| | | 13 | 293 |
| | | 14 | 294 |
| | | 15 | 295 |
| | | 16 | 296 |
| | | 17 | 297 |
| | | 18 | 298 |
| | | 19 | 299 |
| | | 20 | 300 |
| | | 21 | 301 |
| | | 22 | 302 |
| | | 23 | 303 |
| | | 24 | 304 |
| | | 25 | 305 |
| 客電(未使用) DMX No. 306~312 | | 26 | 306 |
| | | 27 | 307 |
| | | 28 | 308 |
| | | 29 | 309 |
| 予備 | | 30 | 310 |
| | | 31 | 311 |
| | | 32 | 312 |
| | | 1 | 313 |
| | 2 | 314 | |
| | 3 | 315 | |
| | 4 | 316 | |

| 名称 | | DMX | CH |
|-------------|--|-----|-----|
| 移動型 調光器① | | 1 | 311 |
| | | 2 | 312 |
| | | 3 | 313 |
| 移動型 調光器② | | 1 | 314 |
| | | 2 | 315 |
| | | 3 | 316 |
| 移動型 調光器③ | | 1 | 317 |
| | | 2 | 318 |
| | | 3 | 319 |
| 移動型 調光器④ | | 1 | 320 |
| | | 2 | 321 |
| | | 3 | 322 |
| 移動型 調光器⑤ | | 1 | 323 |
| | | 2 | 324 |
| | | 3 | 325 |
| 移動型 調光器⑥ | | 1 | 326 |
| | | 2 | 327 |
| | | 3 | 328 |

| | | |
|-----------|-----------|-----|
| (リクリZM2台) | 1 | 237 |
| CL 上手側 | 2 | 238 |
| | 3 | 239 |
| | 4 | 240 |
| | (リクリZM2台) | 5 |
| | 6 | 242 |
| | 7 | 243 |
| | 8 | 244 |
| | 9 | 245 |
| | 10 | 246 |
| CL センター | 11 | 247 |
| | 12 | 248 |
| | 13 | 249 |
| | 14 | 250 |
| | 15 | 251 |
| | 16 | 252 |
| (リクリZM2台) | 17 | 253 |
| | 18 | 254 |
| CL 下手側 | 19 | 255 |
| | 20 | 256 |
| (リクリZM2台) | 21 | 257 |

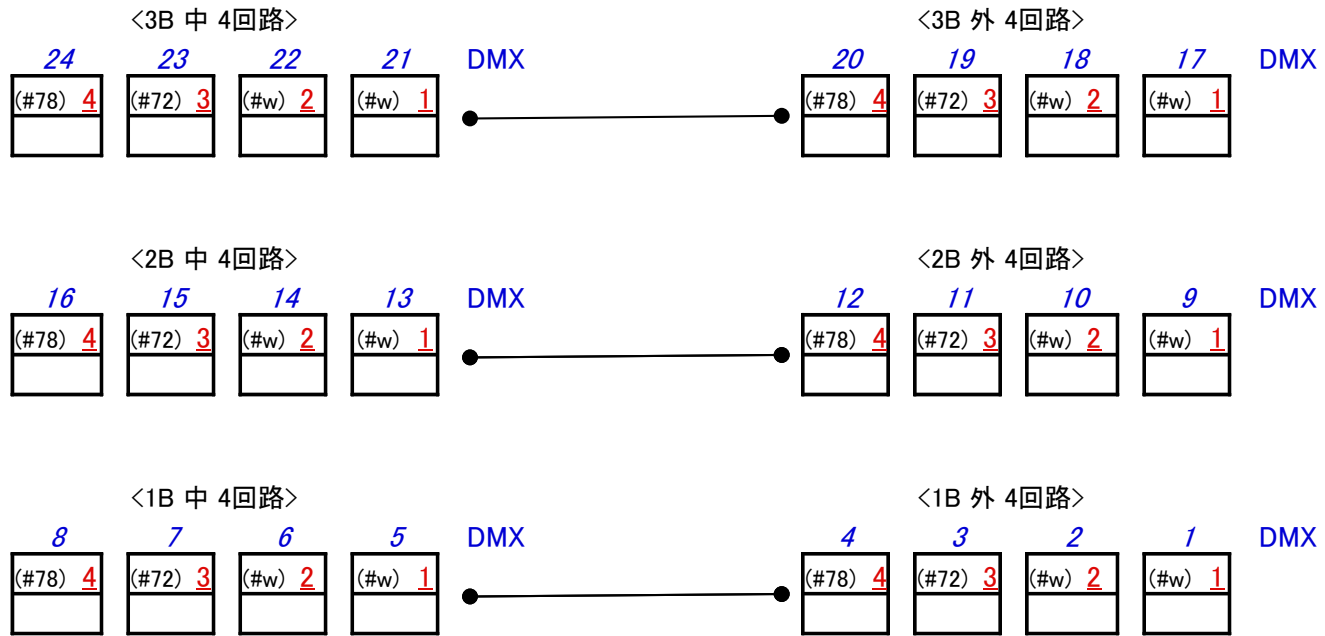
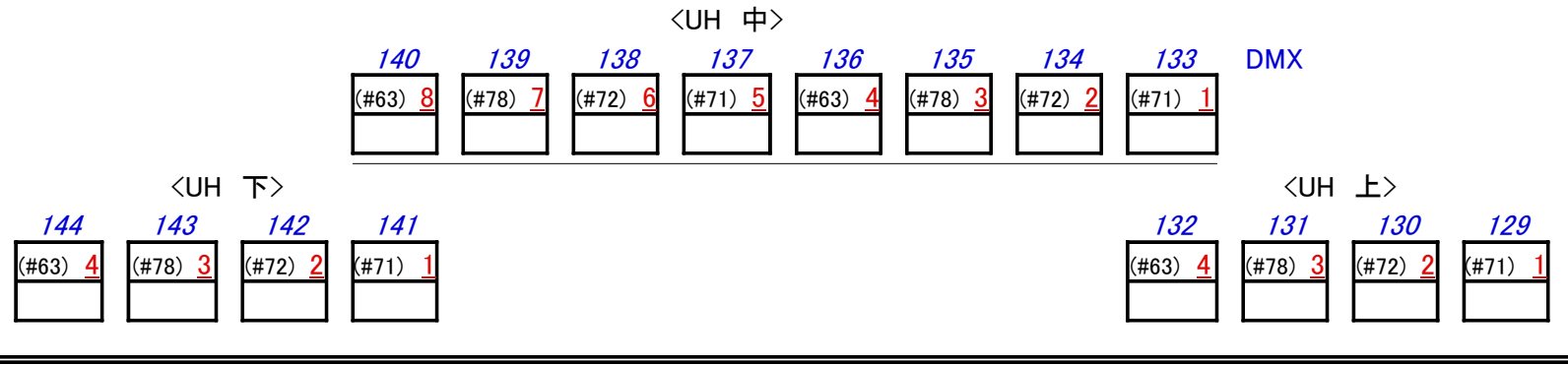

No.3 フロアコンセント.花道コンセント

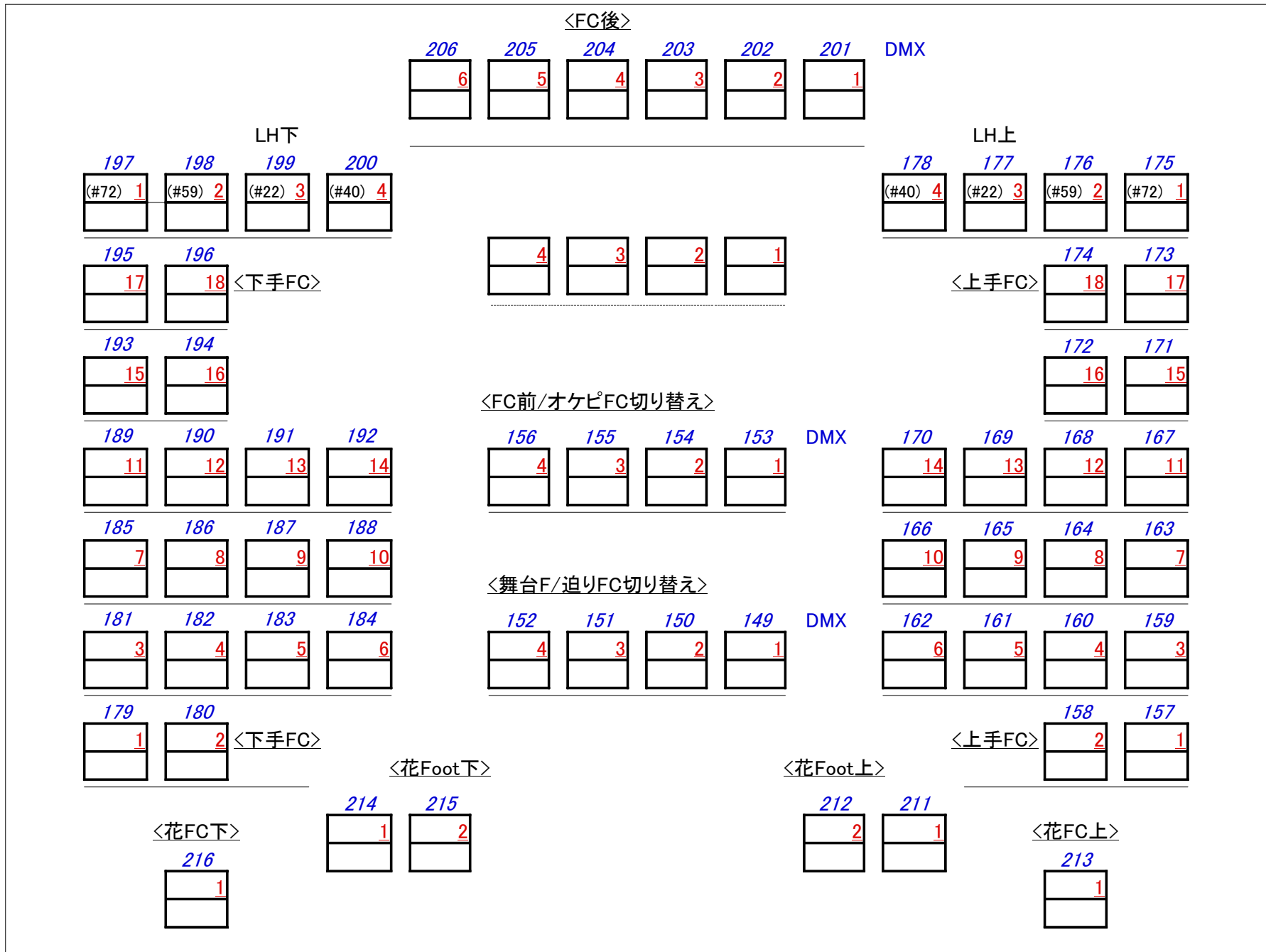

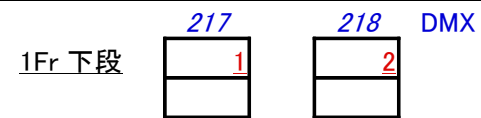
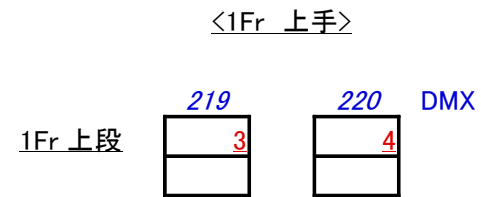
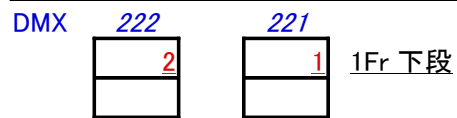
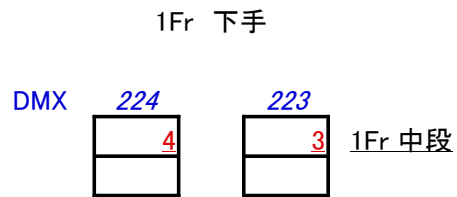
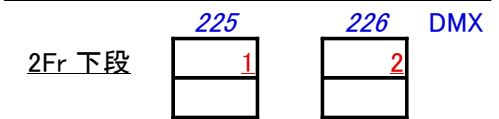
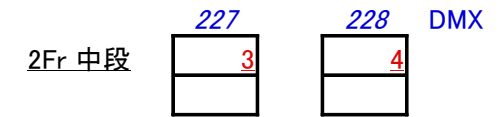
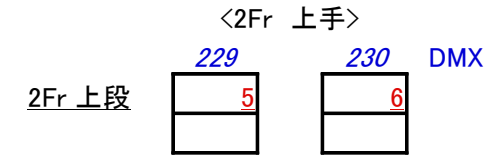
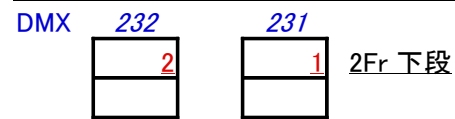
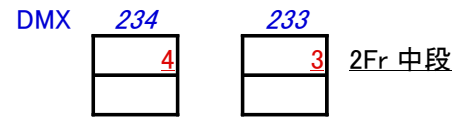
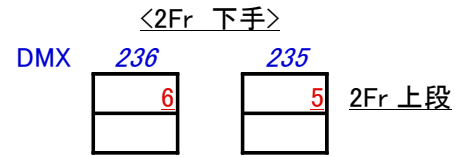

<CL>

